

Article number: 03441200

Description: Fluro Rod end GE 200EC-2RS

Measures

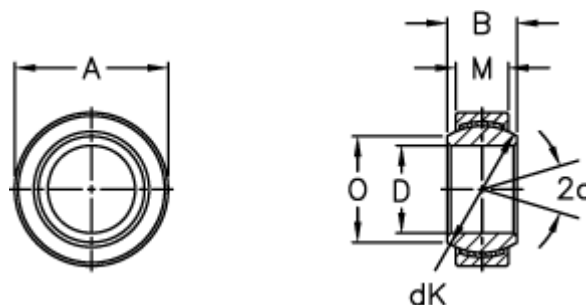

A = 290 0 -0,035

B = 130

D = 200 0 -0,030

dK = 250

Dynamic load C (kN) = 4000

M = 100

O = 213.5

Static load C0 (kN) = 8000

Tilt angle = 7

Weight = 28000